



# **BS5000 (51.2V 100Ah) Lithium Iron Phosphate Battery User Manual**



**Directory**

Directory.....	2
1. Notes.....	3
2. Introduction.....	4
3. Characteristics.....	4
4. Parameter Specifications.....	5
4.1 Dimensions.....	5
4.2 Battery Parameters.....	5
4.3 Interface Definitions.....	6
5. LiFePO4 Battery Safety Operating Guidelines.....	9
5.1 Application Schematic.....	9
5.2 Tools.....	9
5.3 Security equipment.....	9
6 Installation.....	10
6.1 Installation location.....	10
6.2 Installation.....	10
7. Maintenance Precautions .....	11
8. FAQ Analysis and Solutions .....	11

## 1. NOTES



### **Attention!**

(1) It is important and necessary to read the user manual carefully before installing or using the battery. The safety precautions mentioned in this manual do not represent all safety matters to be observed and only complement all safety precautions;

(2) When installing, operating and maintaining equipment, local safety regulations shall be observed and followed;

(3) Do not wear any conductive objects such as watches, bracelets, and rings when installing, operating and maintaining equipment;

(4) If the battery is stored for long before installation, it needs to be charged and discharged every six months, and the battery charge percentage shall not be less than 70%;

(5) If the battery is fully discharged, it should be charged within 12 hours;

(6) Before maintenance, batteries and equipment must be cut off firstly;

(7) Do not use cleaning solvents to clean batteries;

(8) Do not expose batteries to flammable or irritating chemicals or vapors;

(9) Do not connect batteries directly to photovoltaic solar wires;

(10) Our company is not responsible for any loss caused by violation of general safety operation requirements or violation of design, production and use of equipment safety standards.



### **Warning!**

#### **1.1 Before Installation**

1.1.1 After unpacking, please check the product and packing list first, if the product is damaged or missing any parts, please contact the seller;

1.1.2 Before installation, cut off the power supply and ensure the battery is off;

1.1.3 Wiring must be correct, do not mistake positive(+) and negative(-) cables, and ensure the external devices are not short-circuited;

1.1.4 Direct connection of batteries and AC power is prohibited;

1.1.5 Battery protection system is designed for 48V DC, no series connections allowed;

1.1.6 Please ensure that the electrical parameters of the battery system are compatible with the relevant equipment;

1.1.7 Keep the battery away from water and fire.

## **1.2 Usage**

1.2.1 If the battery system needs to be moved or repaired, the power must be cut off and the battery completely stops working;

1.2.2 It's prohibited for connecting this battery to other different type of batteries;

1.2.3 It's prohibit for connecting this battery with any faulty or incompatible devices;

1.2.4 When fire occurs, only dry powder fire extinguishers can be used, liquid fire extinguishers are prohibited;

1.2.5 Do not disassemble batteries privately;

## **2. Introduction**

This battery is a new type of energy storage product, which can be used to provide reliable power supply for various equipment and systems. It is especially suitable for applications with large power, limited installation space, limited bearing capacity and long life. Battery built-in BMS -battery management system, battery voltage, current, temperature and other information management and monitoring. In addition, the battery pack can balance the charge and discharge of the battery to prolong the cycle life. Multiple battery packs can be parallel to expand capacity and power, parallel to expand capacity and longer power support time requirements.

### 3. Characteristics

- ☆ Environmental protection and pollution-free: the whole battery module using materials are non-toxic, pollution-free;
- ☆ long safety life: the core cathode material of battery module is made of LiFeOP4, good safety performance and long service life;
- ☆ Protection function: battery management system can protect battery module over discharge, over charge, over current and high / low temperature;
- ☆ Equilibrium function: the battery management system has its own passive equalization, can balance the battery module each single string core;
- ☆ Expansion: flexible configuration, multiple battery modules can be parallel expansion capacity, applicable to different standby time requirements;
- ☆ Low power consumption: the battery has the function of automatic dormancy, when no live equipment is connected, it can enter the low power state by itself and reduce the self-loss;
- ☆ No memory: no memory effect, shallow charge and discharge performance is excellent;
- ☆ Wide temperature range: working temperature range-20~70, charge 0~60, discharge-20~70, good discharge performance and cycle life,

Portable: Small, lightweight, standard 19-inch embedded module easy to install and maintain

## 4. Parameter Specifications

### 4.1 Dimensions

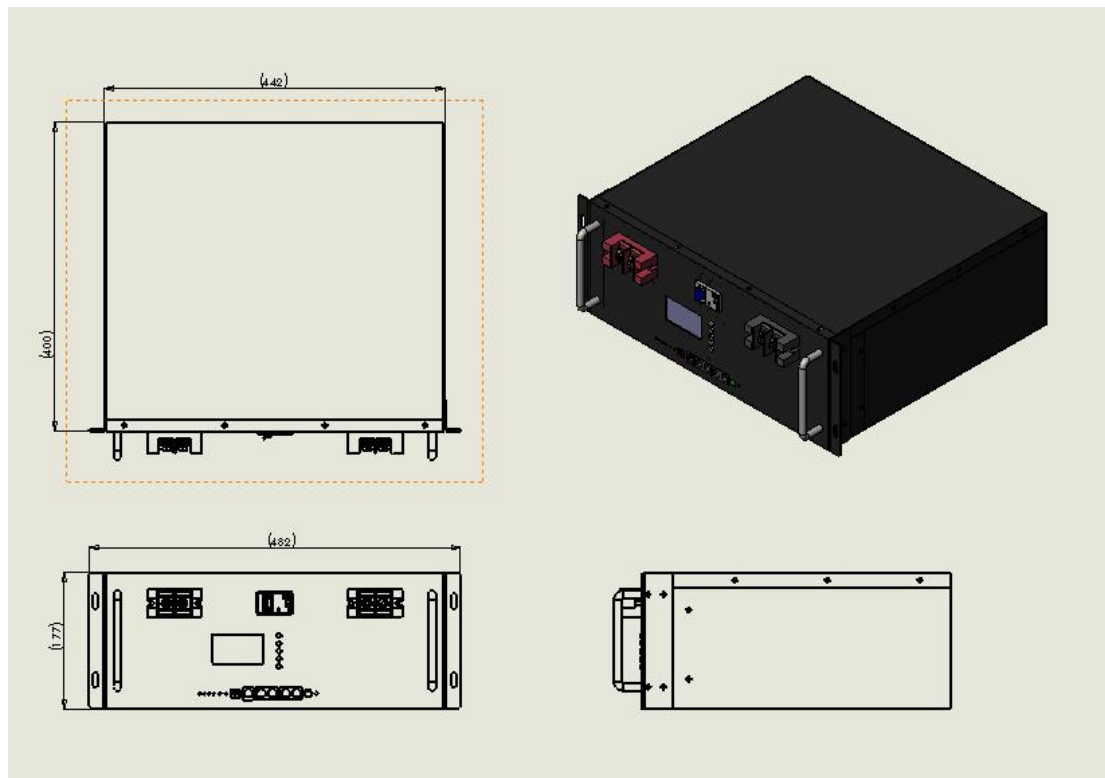

### 4.2 Battery Parameters

Project	Parameters
Model	BS5000 (51.2V100Ah)
Nominal voltage	51.2V
Nominal capacity	100Ah
Combination mode	16 Series
Dimensions W×D×H (mm)	482×400×177
Weight	About 45KG
Working voltage	43.2-58.4V
Charging voltage	56.8--58.4V
Charging current limiting	10A (The default charging current is greater than 55A, and the current limiting is on)
Standard charging current current	20A (0.2C)
Maximum continuous charging current	50A (0.5C)
Standard discharge current	20A (0.2C)
Maximum continuous discharge current	100A (1.0C)
Charging temperature range	0~50°C

Discharge temperature range	-20~60°C
Monitoring communications	RS232, RS485, CAN
Number of cycles	3000 Cycles
Working environment	Humidity :≤95; Altitude :≤4000

### 4.3 Interface Definitions

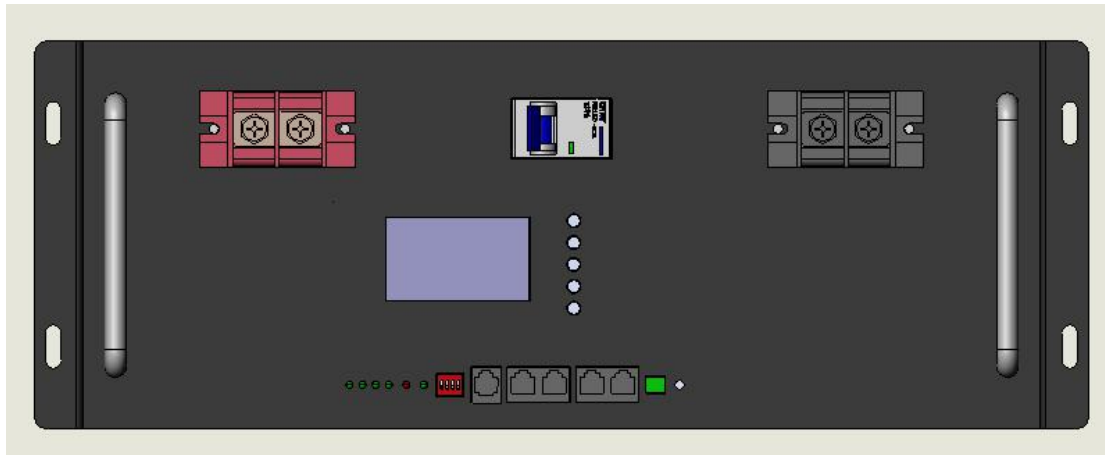

#### 4.3.1 RET: Reset key

When the BMS is dormant, press reset button for 3 seconds and release, the protection board will be activated, and LED indicator will light up in 0.5 seconds from "RUN" button.

When the BMS is active, press reset button 3 seconds and release, the protection board is dormant, and the LED indicator lights up for 0.5 seconds from the lowest power lamp.

When the BMS is activated, press reset button for 6 seconds and release, the protection board is reset, and the LED lights are lit for 1.5 seconds at the same time.

after the BMS is reset, the parameters and functions set through the upper computer will be retained. If to restore to the initial parameters, it can be achieved through the upper computer's "restore default value ", but the relevant running records and storage data will remain unchanged (such as electricity, cycle times, protection records, etc).

#### 4.3.2 RS485-1 /CAN

RJ45 interface, is used for external communication of battery pack, such as inverter, computer

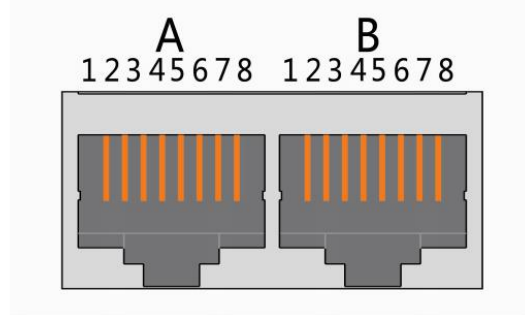

X1(双RJ45)端口

接口	定义说明		定义说明			
X1 通讯端口定义	A 部分 CAN 接口	PIN 1	CANL	B 部分 RS-485-1 接口	PIN 1	RS485-B1
		PIN 2	CGND		PIN 2	RS485-A1
		PIN 3	NC(空)		PIN 3	RS485-GND
		PIN 4	CANH		PIN 4	RS485-B1
		PIN 5	CANL		PIN 5	RS485-A1
		PIN 6	NC(空)		PIN 6	RS485-GND
		PIN 7	CGND		PIN 7	NC(空)
		PIN 8	CANH		PIN 8	NC(空)

### 4.3.2 RS485-2

With a dual RS485 interface, the default baud rate is bps.9600 can be expanded in parallel battery pack, communication interconnection.

### 4.3.3 RS232:

Default baud rate bps .9600

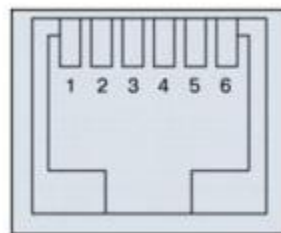

RS232--采用 6P6C 立式 RJ11 插座	
RJ11 引脚	定义说明
2	NC
3	TX ( 单板 )
4	RX ( 单板 )
5	GND



#### 4.3.4 ADD :

Address switch: four address switches, used to determine where the different communication address is. The lower position is off, which means 0. The upper position is on, which means 1.

When the PACK is used in parallel, different addresses can be distinguished by the dial switch on the BMS. To avoid setting the address to the same PACK, the definition of the dial switch is referred to the table below.

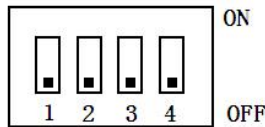

Address	Dial switch position			
	#1	#2	#3	#4
0	OFF	OFF	OFF	OFF
1	ON	OFF	OFF	OFF
2	OFF	ON	OFF	OFF
3	ON	ON	OFF	OFF
4	OFF	OFF	ON	OFF
5	ON	OFF	ON	OFF
6	OFF	ON	ON	OFF
7	ON	ON	ON	OFF
8	OFF	OFF	OFF	ON
9	ON	OFF	OFF	ON
10	OFF	ON	OFF	ON
11	ON	ON	OFF	ON
12	OFF	OFF	ON	ON
13	ON	OFF	ON	ON
14	OFF	ON	ON	ON
15	ON	ON	ON	ON

#### 4.3.5 indicator

Table 1 LED Working status indicators

State	Normal/alert/protection	RUN	ALM	Electricity indicator LED				Note
		●	●	●	●	●	●	
Shutdown	Sleep	Elimination	Elimination	Elimination	Elimination	Elimination	Elimination	Total extinction
Standby	Normal	Flash 1	Elimination	According to the electricity indicator				Standby status

	Alarm	Flash 1	Flash 3					Module Low Voltage
Charge	Normal	Always bright	Elimination	According to the electricity indicator (power indicator maximum LED flash 2)				Maximum power LED flash (flash 2), overcharge alarm ALM no flicker
	Alarm	Always bright	Flash 3					
	Overcharge protection	Always bright	Elimination	Always bright	Always bright	Always bright	Always bright	If there is no electricity, the indicator is in standby state
	Temperature, overcurrent, failure protection	Elimination	Always bright	Elimination	Elimination	Elimination	Elimination	Stop charging
Discharge	Normal	Flash 3	Elimination	According to the electricity indicator				
	Alarm	Flash 3	Flash 3					
	Undercurrent protection	Elimination	Elimination	Elimination	Elimination	Elimination	Elimination	Stop discharge
	Temperature, overcurrent, short circuit, reverse connection, failure protection	Elimination	Always bright	Elimination	Elimination	Elimination	Elimination	Stop discharge
Failure		Elimination	Always bright	Elimination	Elimination	Elimination	Elimination	Stop charging and discharging

Table 2 Description of capacity indication

State		Charge				Discharge			
Capacity indicator		L4●	L3●	L2●	L1●	L4●	L3●	L2●	L1●
Electricity (%)	0~25%	Elimination	Elimination	Elimination	Flash 2	Elimination	Elimination	Elimination	Always bright
	25~50%	Elimination	Elimination	Flash 2	Always bright	Elimination	Elimination	Always bright	Always bright
	50~75%	Elimination	Flash 2	Always bright	Always bright	Elimination	Always bright	Always bright	Always bright

	75~100%	Flash 2	Alwa ys bright	Alwa ys bright	Alwa ys bright	Alwa ys bright	Alwa ys bright	Alwa ys bright	Alwa ys bright
● running indicator		Always bright			Flash (flash 3)				

## 5. LiFePO4 Battery Safety Operating Guidelines

### 5.1 Application Schematic

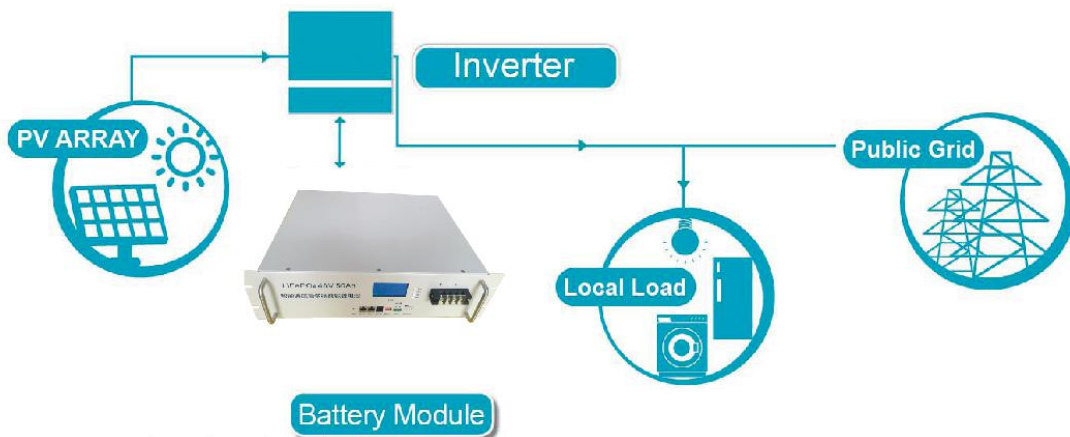

### 5.2 Tools

The following tools are needed to install batteries



Use insulated tools to prevent accidental electric shock or short circuit. If there is no insulation tool, use insulation tape to cover all exposed metal surfaces of the tool for insulation treatment.

### 5.3 Security equipment

When handling the battery pack, it is recommended to wear the following safety equipment.



## 6. Installation

### 6.1 Installation location

Ensure that the installation location meets the following conditions:

6.1.1 The area is completely waterproof.

6.1.2 The installation wall is flat.

6.1.3 No flammable and explosive items in nearing position

6.1.4 Ambient temperature is between 0°C and 50°C, the temperature and humidity remain constant.

6.1.5 This area has little dust and dirt.



### Attention

If the ambient temperature is out of working range, the battery pack will stop to work. The optimal operating temperature of the battery ranges from 0 to 50 degrees Celsius. When often exposed to harsh temperatures, it'd affect for battery's performance and lifetime.

### 6.2 Installation

Put the battery module into the mounting cabinet or bracket and connect the wire.



Note: When the battery is placed or pulled out of the rack, beware of the battery slipping out

When multiple batteries are connected in parallel, as shown below:

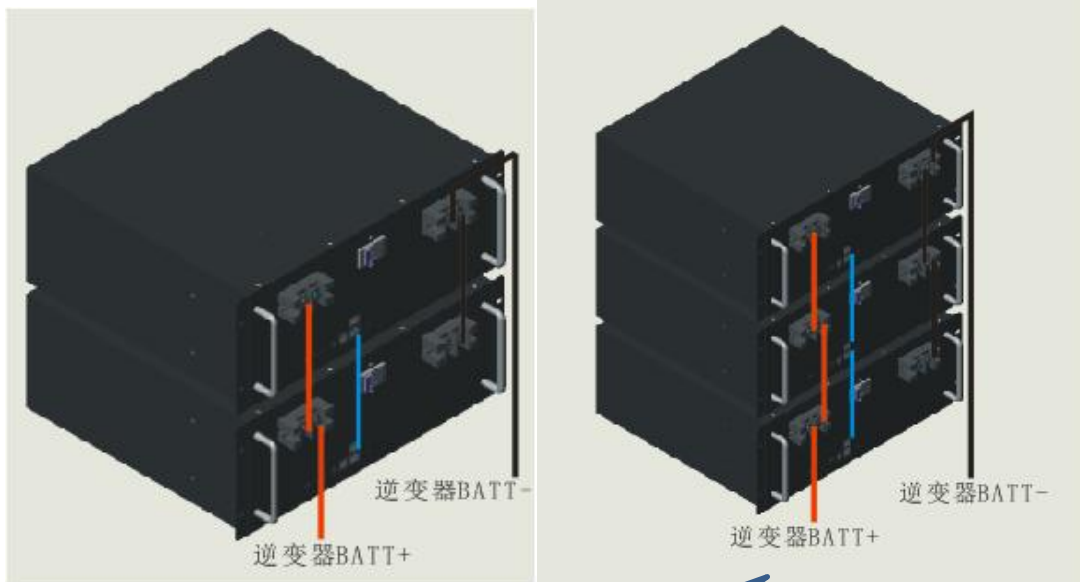

Note: when connecting the equipment, the battery output positive and negative electrodes should be taken from the first group and the last group of batteries

## 7. Maintenance Precautions

In the later stage of installation and use, the iron lithium battery can be simply maintained and inspected, because of its maintenance-free characteristics, the maintenance period can be extended, such as once every 3 months.

- ◆ Check whether the pole column and connection lines of LiFePO4 battery are loosed, damaged, deformed or corroded, and whether the battery case is damaged or deformed;
- ◆ Observe the state of the battery pack running indicator light, normal state is green light, battery pack CAPCITY light only the last flicker, indicating that the battery power is low, the battery is about to dry off the output;
- ◆ When there is a failure, the battery pack flashes ALM the red light and sends out an alarm. Please check whether the battery connection is correct or over-current; then press the RST reset key to see if the failure is eliminated after the battery restarts. If it can not be eliminated, please contact the manufacturer to handle, do not open the battery case;
- ◆ For a multi-battery parallel application scenario, if one of the battery fails and needs to be replaced, make sure that the voltage difference between the newly replaced battery and the other batteries to be parallel is within 2V, if the Voltage difference is large, High voltage battery pack charge low voltage battery pack large current, low voltage battery pack charge over-current protection, resulting in unable to charge;
- ◆ Record the time and number of power outages, the battery power supply time to do detailed statistics;

## 8. FAQ Analysis and Solutions

### 8.1 Undervoltage alarm

ALM indicator lights flicker, RUN operation indicator lights out.

Cause analysis:

- (1) The load current is too large that exceeds the battery's discharge

protection value.

(2) Battery protection panel failure.

Solution: the protection board will lock the state after entering the over-current state until the charger can be activated at the charging input end.

### **8.2 Discharge over-current protection**

ALM alarm indicator lights flicker, RUN operation indicator lights out.

Cause analysis:

(1) The load current is too large that exceeds the battery's discharge protection value.

(2) Battery protection panel failure.

Solution: the protection board will lock the state after entering the over-current state until the charger can be activated at the charging input end.

### **8.3 Temperature Protection**

ALM alarm indicator lights flicker, RUN operation indicator lights out.

Cause analysis: Ambient temperature may be too high or too low

Solution: when the temperature at the NTC end returns to normal, the protection board recovers from the temperature protection state and the red ALM lamp goes out.

### **8.4 Battery No Voltage Output**

The power indicator lights out, the voltage at both ends of the battery is 0 V.

Cause analysis: the battery is not activated or the battery management system is abnormal.

Solution: activate the battery or reset the battery through the reset key on the battery panel in the activated state "RST", there is still no voltage output, contact the manufacturer professional to handle.